

RV-EC

THERMOSTAT

A. RV-ECWP SERIES (ORDINARY TYPE)

Pressure-type thermostat for window air conditioners and split air conditioners

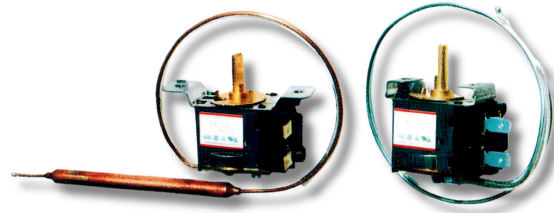

B. RV-ECWY-S SERIES (HIGH TEMPERATURE TYPE)

Manual reset thermal cut-off for electric water heaters and other electric heating appliances

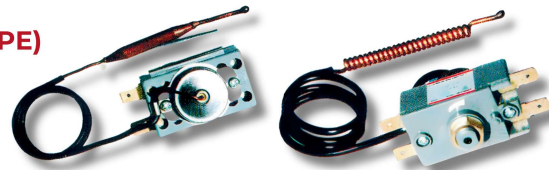

C. RV-ECWY-F SERIES (HIGH TEMPERATURE TYPE)

Liquid expansion type thermostat for electric heating appliances including electric water heaters, washing machines, electric ovens, deep fryers, and hot water dispensers.

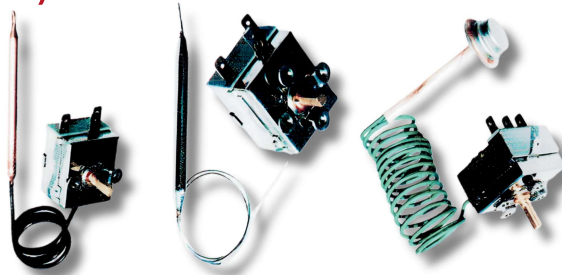

D. RV-ECWDF SERIES (CONSTANT TEMPERATURE & REPOSITIONING TYPE)

Pressure thermostat for refrigerator and freezer applications.

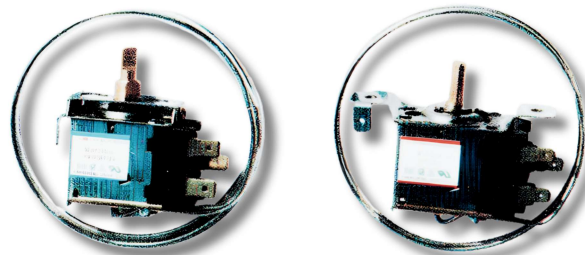

RV-EC

THERMOSTAT

D SERIES

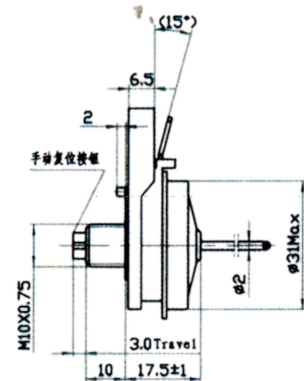
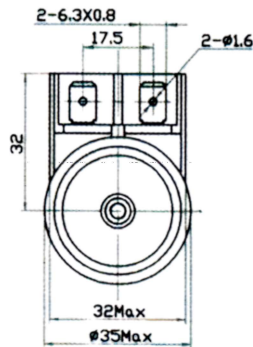
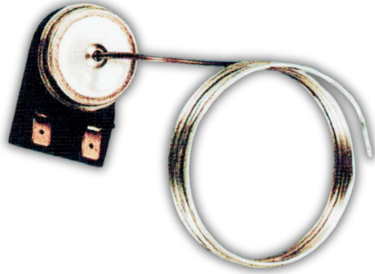

Contact Capacity: **16A/400V**
 Temperature range: **75-130°C**
 Application: **Overheat protection for water heaters, boilers, and related equipment**
 Housing temperature rating: **T85**
 Capillary length: **300-1500 mm**

Type of Sensing Element:

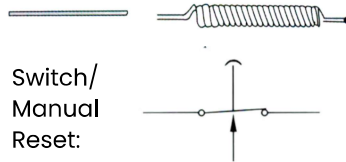

Terminal Direction:

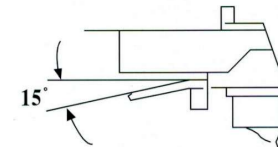

A 2000 SERIES / F 2000 SERIES

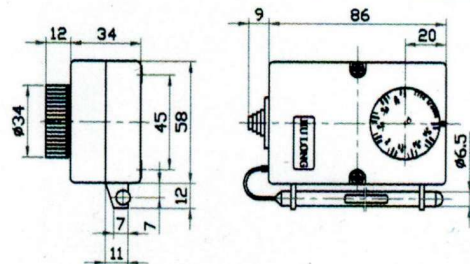
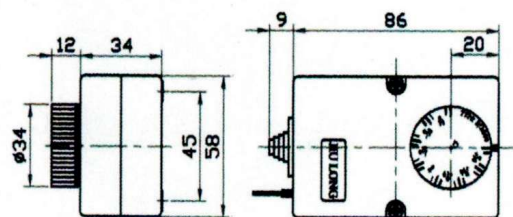
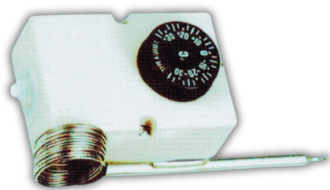
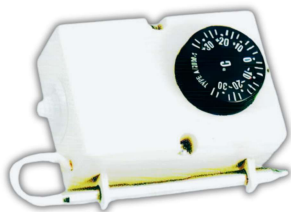

Contact Capacity: **C-116A C-2 4A/250V**
 Temperature range: **-35-35°C / 0-40°C**
 Application: **Cold storage and refrigerated chambers**
 Capillary length: **150-3000 mm**
 Switching differential: **1-3°C**

Switch:

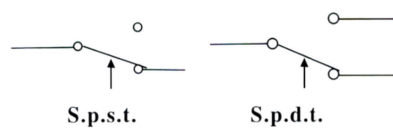

FEATURES

- Available in normally open (NO) and normally closed (NC) types
- Available in single pole single throw (SPST) and single pole double throw (SPDT) types
- Maximum load current: 45A at 240V
- Different cover types and mounting angles can be provided according to customer requirements

APPLICATIONS

Air compressors, heating and ventilation systems, vending machines, clothes dryers, heating elements, and related equipment.

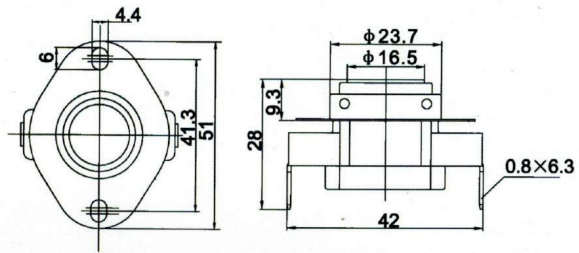

RV-ECT-001



RV-ECT-002



RV-ECT-003



RV-ECT-004



RV-ECT-004A



RV-ECT-005



RV-ECT-007



RV-ECT-007B

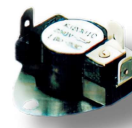

RV-ECT-008



RV-ECT-009

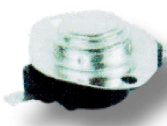

RV-ECT-011



RV-ECT-017



RV-ECT-018



RV-ECT-021



RV-ECT-022

RV-EC

THERMOSTAT

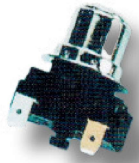

RV-ECT-023



RV-ECT-025



RV-ECT-027



RV-ECT-027R



RV-ECT-030



RV-ECT-040



RV-ECT-013A



RV-ECT-013B

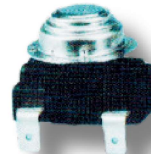

RV-ECT-013



RV-ECT-013R



RV-ECT-014B

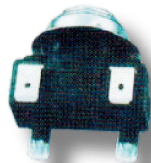

RV-ECT-014



RV-ECT-014R



RV-ECT-301

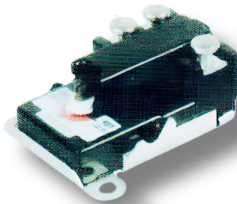

RV-ECT-201

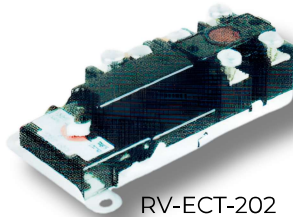

RV-ECT-202

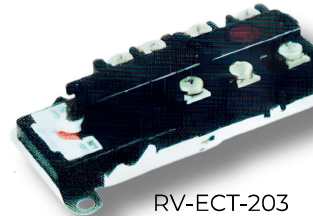

RV-ECT-203



RV-ECT-204

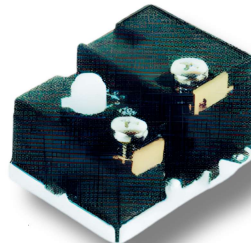

RV-ECT-205



RV-ECT-206